

to protect your product,
read operating instructions before opening parasol

TUUCI®

made in miami

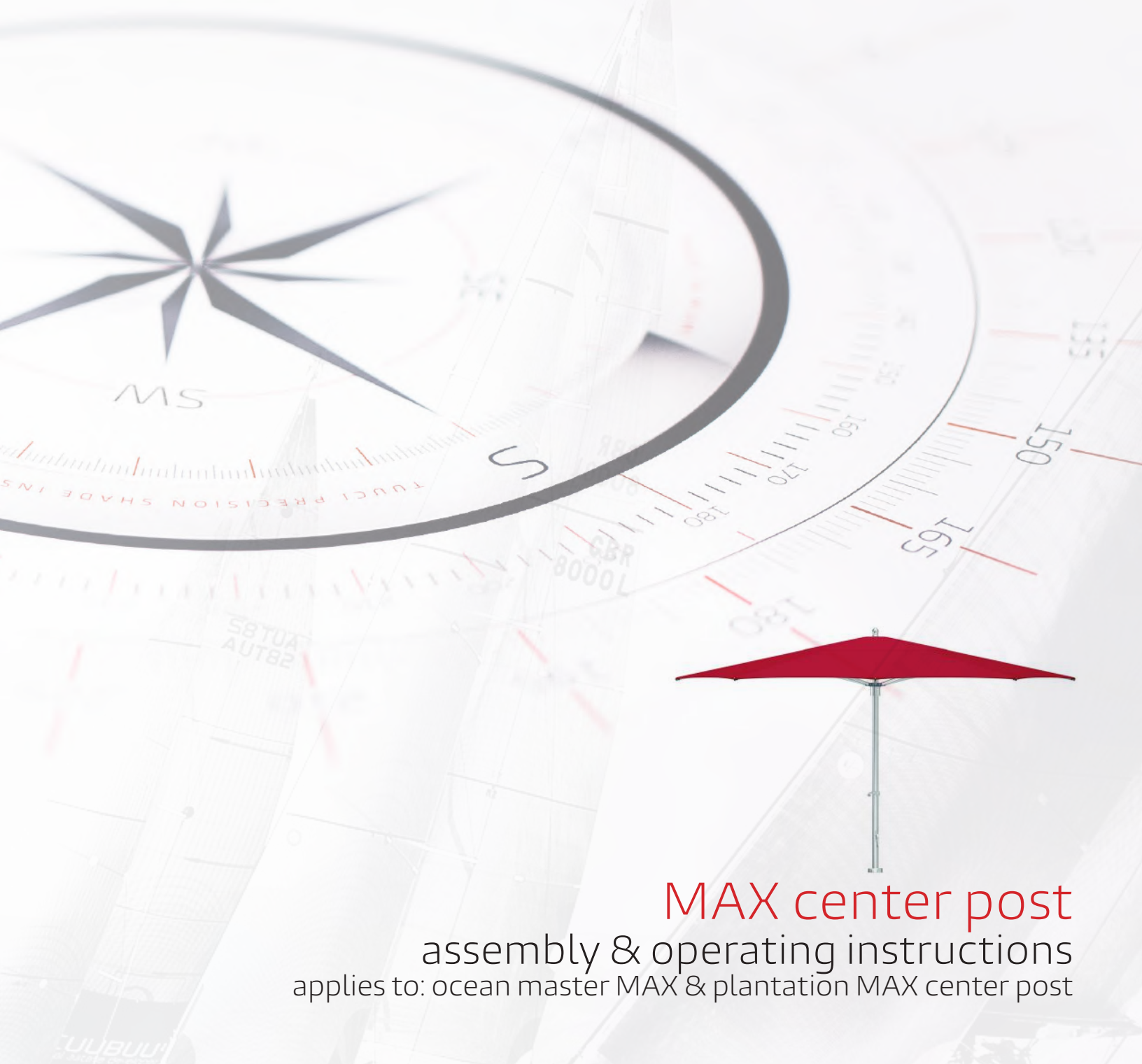

MAX center post
assembly & operating instructions
applies to: ocean master MAX & plantation MAX center post

Step 1

Remove all packaging from umbrella, including inside the umbrella.

Step 2

Remove pin and lift up cam lock handle

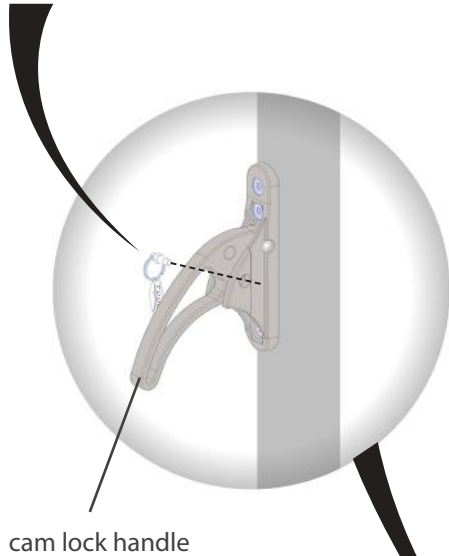

cam lock handle

Step 3

Remove security stem from inside umbrella and mount to your base (instructions included with base)

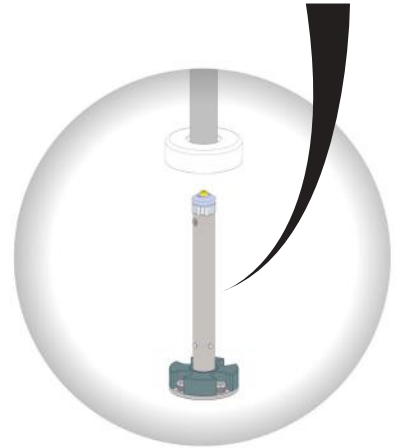

Step 4

Mount umbrella onto security stem, push down cam lock handle and insert pin.

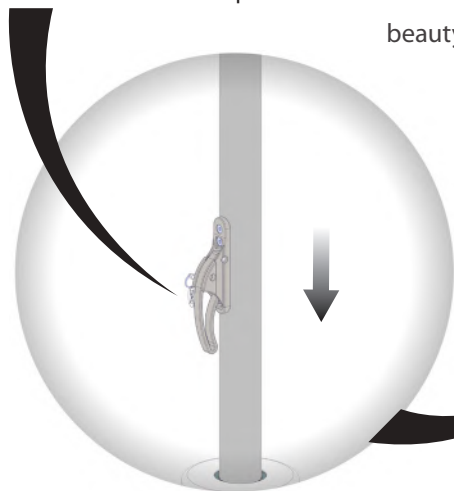

beauty cover

security stem

Step 5

Separate each rib from center pole approx. 10 inches



applies to:



square



octagon



rectangle

EASY DRIVE SYSTEM
refer to page 4

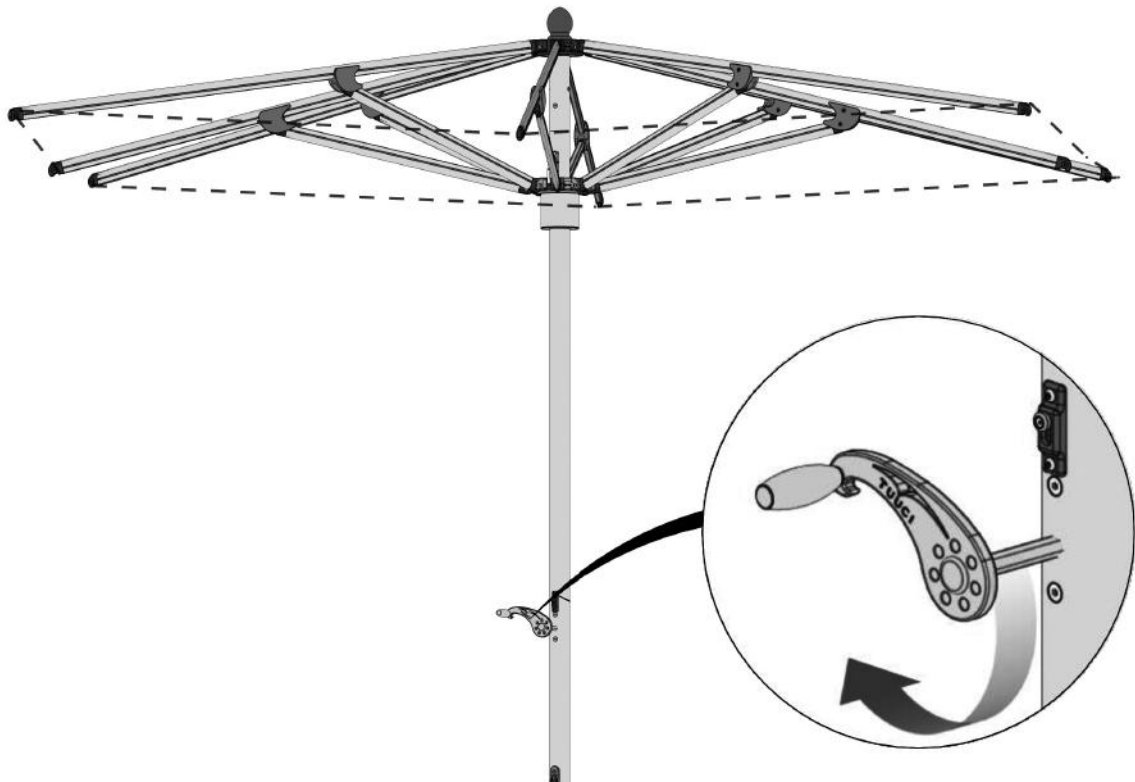

AUTO-LOC LIFT SYSTEM
refer to page 5

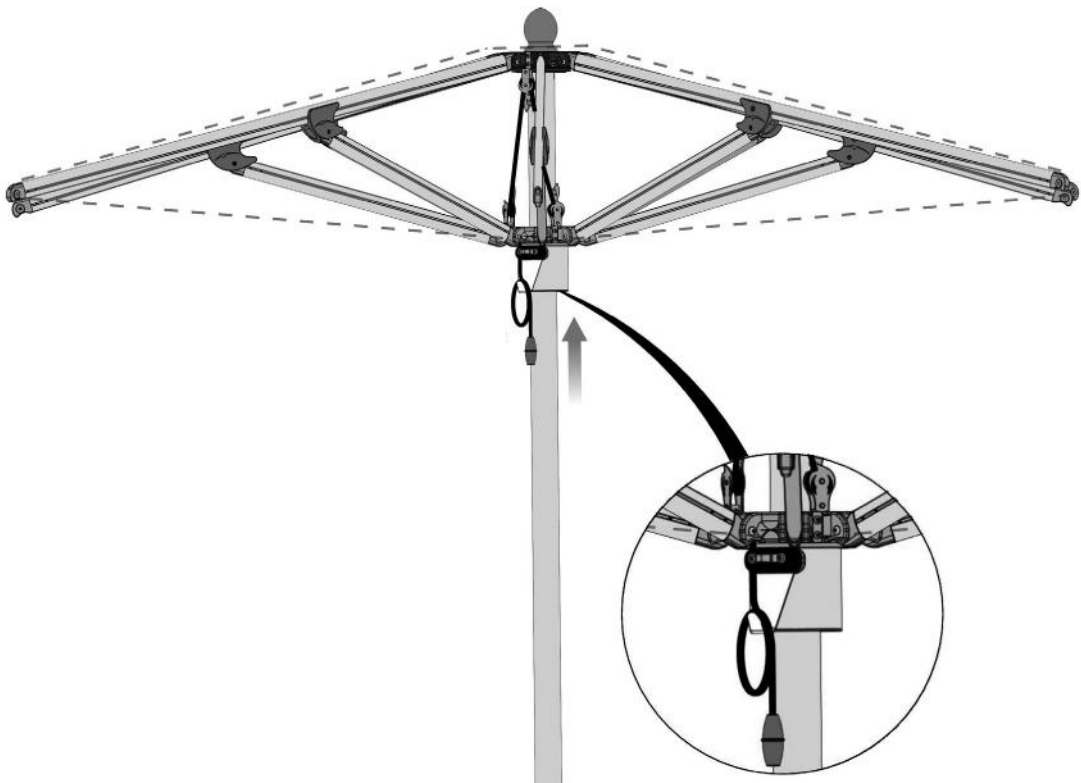

EASY DRIVE SYSTEM

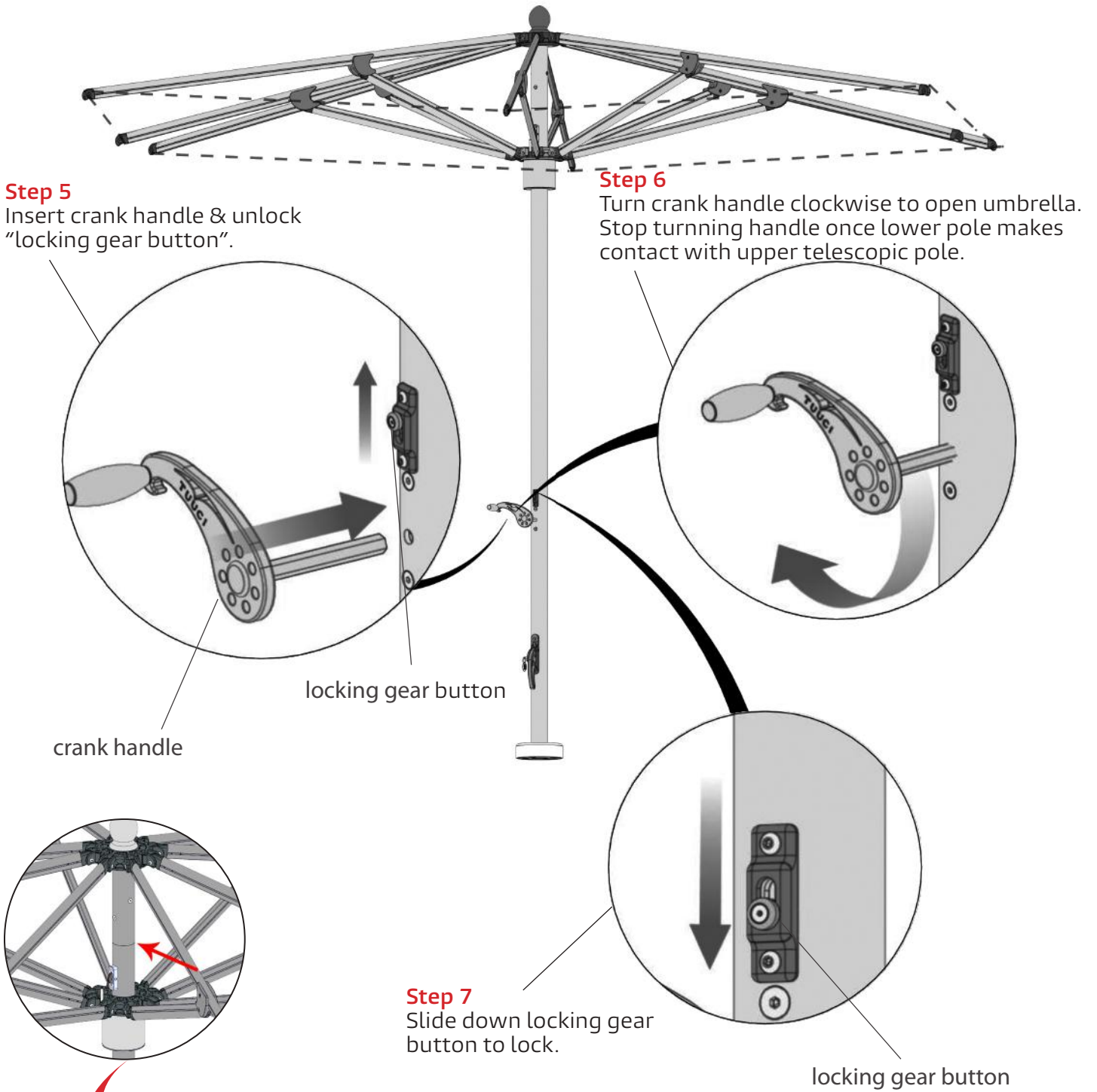

***** Important*****

Do not overcrank. Stop when top telescopic head makes contact with main umbrella pole

Note: close umbrella during wind conditions that exceed manufacturer's specifications.

INSA1001

AUTO-LOC LIFT SYSTEM

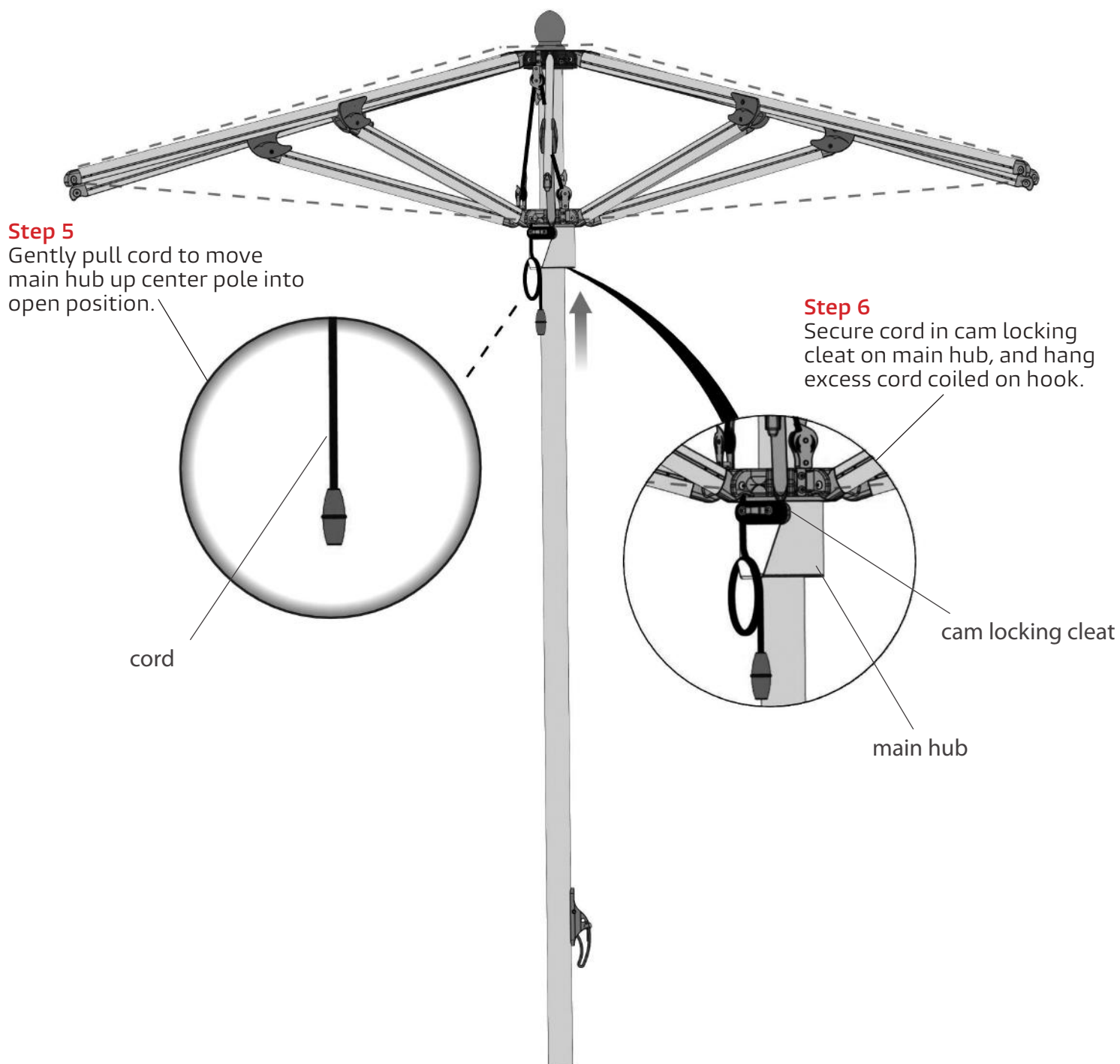

Note: close umbrella during wind conditions that exceed manufacturer's specifications.

TUUCI frames are constructed from durable, marine-grade, weather resistant materials including: fiberglass, armor-wall aluminum, Dura-TEAK composites, Aluma-TEAK aluminum and sustainable hardwood. All fasteners (nuts, bolts, pulleys, cam cleats, etc.) are marine-grade stainless steel and will withstand the most corrosive environments. Proper care and maintenance is important to extend the serviceable life of all TUUCI products. We recommend the following:

- Fresh water rinses once a week
- Weekly inspection of your TUUCI product is recommended. Loose screws should be tightened and any broken components replaced immediately to avoid further damage to your product.
- Prior to opening, ensure that the shade product is properly secured to an adequate shade anchor system.
- When opening a TUUCI parasol, separate each rib 10 inches from the center post, before raising the hub. Do not force hub if it does not rise easily.
- When closing the parasol, pull the fabric out from between the struts to avoid pinching or damaging the TUFF-SKIN canopy membrane.
- TUUCI recommends that all collapsible shade equipment be closed in wind conditions which exceed 25 MPH.
- Clean above ground parasol bases regularly to maintain appearance. To clean, gently wash with soap and water using a nonabrasive cloth or pad.
- Check bolts in security stem regularly to ensure that they remain fully tightened.
- Do not roll Aluma-crete (Aluminum Shell, Concrete Filled) bases on their side as damage to shell or finish can occur.
- Do not use on stairways or over distances which exceed 50 feet, as damage to welded wheel tray may occur.
- Canopy should be cleaned regularly and can be cleaned without being removed from the frame. Hose down and clean with a mild soap and lukewarm water (no more than 100° F.) using a soft bristle brush. Rinse thoroughly to remove soap. Allow fabric to air dry. TUUCI Parts can be purchased at parts@tuuci.com.
- Do not use a pressure washer to clean canopes.

warranty: parasol / cabana / lounge / shade anchor

Product

TUUCI constructs its shade structures with the finest marine-grade materials available. We test our products in extreme weather environments to ensure stability, durability and years of worry-free service. In addition, TUUCI personnel carefully follow specific quality control procedures and inspect each product to ensure freedom from any type of manufacturing defect. Our goal is to produce shade platforms that will exceed your expectations and provide a shade experience like no other in the world. The warranty protection listed below covers manufacturing defects only.

Although all TUUCI marine-grade shade equipment is rigorously tested to withstand incredible forces of nature, TUUCI does not recommend or warranty the deployment or use of any collapsible shade equipment in wind conditions which exceed 25 MPH (45 MPH for the MAX F-1). TUUCI will only warranty products which are properly secured to an adequate base or anchoring system. Furthermore, TUUCI will not cover any damage to a shade or base device which occurs as a result of contact with the ground or any other foreign object including damage which occurs as a result of sudden and severe weather events or other extreme acts of nature. In general, TUUCI recommends that all collapsible shade products be securely closed when not in use.

TUUCI can recommend specific base weight and anchoring systems for specific parasol styles, shapes and sizes, however, TUUCI will only warrant the safe, sensible and reasonable operation of our shade structures within the recommended deployment guidelines. Please contact TUUCI directly if requesting shade devices and anchoring systems which can be warranted in sustained wind conditions which exceed 25 MPH. The following specific time periods and limitations apply to the product indicated:

15 Year Warranty

OCEAN MASTER™, OCEAN MASTER and PLANTATION MAX™ (Classic, Cantilever and F-1) center mast, cantilever mast, top and bottom hubs and stainless steel hardware only. If warrantable damage occurs to the hubs, center pole or stainless steel hardware, TUUCI will replace or repair any item listed in this category at its discretion. Superficial damage, including any type of scratches or abrasions caused from contact with the moving components of the frame itself or canopy during normal operation are not eligible for warranty coverage unless the damage compromises the structural integrity of the frame.

5 Year Warranty

OCEAN MASTER™, OCEAN MASTER and PLANTATION MAX™ (Classic, Cantilever and F-1), STINGRAY SHADE SCULPTURE, connecting brackets, stainless steel fasteners, optional hardware (pulleys, auto-loc lifts, pistons and crank systems), aluminum canopy ribs, and struts. If warrantable damage occurs to the hubs, center pole or stainless steel hardware, TUUCI will replace or repair any item listed in this category at its discretion. Superficial damage, including any type of scratches or abrasions caused from contact with the moving components of the frame itself or canopy during normal operation are not eligible for warranty coverage unless the damage compromises the structural integrity of the frame.

TUUCI CABANA and LOUNGE structures, including the tubing, hub system, and fasteners. If warrantable damage occurs to the hubs, center pole, struts or stainless steel hardware, TUUCI will replace or repair any item listed in this category at its discretion. Please remove fabric canopy tops to any TUUCI CABANA or LOUNGE product for winds exceeding 35 MPH, except where product is specifically engineered and warranted for higher wind loads according to TUUCI's engineering and usage guide.

Level "C" fabric (SUNBRELLA® 9.25 oz. and other TUUCI Tuff Skin marine-grade fabric fabric). If any fabric (SUNBRELLA® or other TUUCI Tuff Skin) Level "C" fabric is rendered unserviceable by loss of color or strength caused by UV degradation, mildew, rot or atmospheric chemicals, TUUCI will replace or repair the fabric at its discretion. Labor charges will apply to the cutting and sewing of any fabric replaced under warranty.

3 Year Warranty

BAY MASTER and VINEYARD (Classic, fiber-Flex, ultra-Flex and Cantilever umbrellas), BAY MASTER MAX and MISTRAL hardwood umbrellas, including the center pole, side mast, hub system, fasteners and canopy ribs. If warrantable damage occurs to the hubs, center pole, struts or stainless steel hardware, TUUCI will replace or repair any item listed in this category at its own discretion. Superficial damage, including any type of scratches or abrasions caused from contact with the moving components of the frame itself or canopy during normal operation are not eligible for warranty coverage unless the damage compromises the structural integrity of the frame.

Level "A" and "B" fabric (SUNBRELLA® 8 oz. and other TUUCI Tuff Skin furniture-grade fabric fabric). If any fabric (SUNBRELLA® or other TUUCI Tuff Skin) Level "A" or "B" fabric is rendered unserviceable by loss of color or strength caused by UV degradation, mildew, rot or atmospheric chemicals, TUUCI will replace or repair the fabric at its discretion. Labor charges will apply to the cutting and sewing of any fabric replaced under warranty.

1 Year Warranty

Powder coat finish of aluminum frames and bases including TUUCI's exclusive aluma-TEAK finish. If any TUUCI applied finish flakes, bubbles, peels, or loses color within one (1) year from the date of purchase, TUUCI will replace or repair any paint finish damage at its own discretion.

The limited warranties outlined above cover only manufacturer defects, not damage caused by the product striking the ground or other object. The redeemable value of all warranties provided herewith shall be prorated over the life of the specific limited warranty itself. In all cases, the warranty claimant shall be responsible for all shipping and/or freight charges incurred by claimant or TUUCI as a result of a warranty claim. Warranty covers only parts and the labor to manufacture the parts for non-fabric claims. Labor for installation of parts covered under TUUCI Warranty is not included. Fabric warranties shall never include the cost of labor and any associated fabrication costs. All warranty claims must be submitted with an original proof of purchase dated from the dealer of origin, a description of damaged product, including how the damage occurred, along with photos of the damaged product. The foregoing warranties may not be assigned and are available only to the original purchaser of TUUCI products. TUUCI reserves at its sole discretion the right to repair, replace, or redesign any product that is returned as a result of a warranty claim.

ALWAYS BUY FROM AN AUTHORIZED TUUCI DEALER

TUUCI proudly sells its products through a carefully selected network of Authorized Dealers. If you purchase through one of our Authorized Dealer partners, you can be sure you are receiving the latest innovation and uncompromising quality you can expect from TUUCI. Beware of those who claim to be authorized dealers but are not in fact part of our Authorized Dealers network. Only purchases from a TUUCI Authorized Dealer will be supported by our warranty program.