

 TREASURE GARDEN™

---

## Assembly and Operation Guide



### STARLUX COLLAR TILT



**UM800xLX** 9' *octagon*

Thank you for purchasing Treasure Garden's Starlux Collar Tilt Umbrella.  
Please remove all contents from the package, inspect and review checklist.

## CHECKLIST

- A - (1) Finial
- B - (1) Canopy/Mainframe
- C - (1) Bottom Pole
- D - (1) Rechargeable Battery Pack
- E - (1) Power Supply\*
- F - (1) BW Base Stopper

\*Note: Use only the Power Supply included with umbrella. See page 6 for Safety Precautions. ⚠

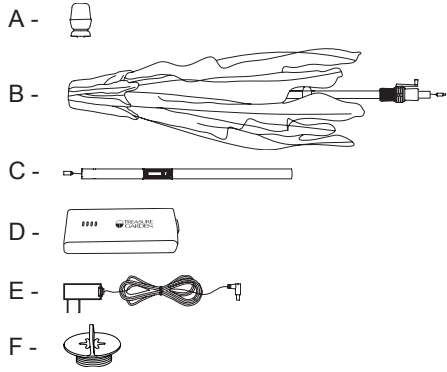

## STEP 1 SET UP

Carefully remove umbrella from box. Attach finial to top of canopy/mainframe. Connect bottom pole and canopy/mainframe plugs together.

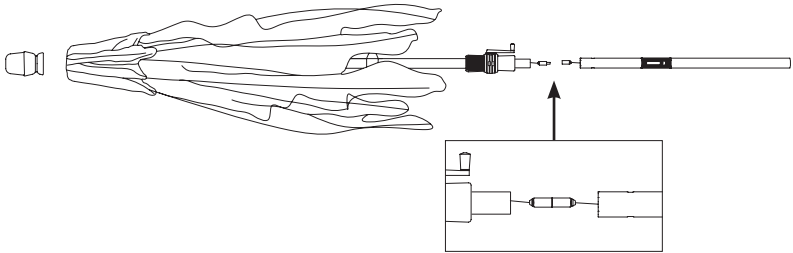

Insert bottom pole into canopy/mainframe pole. **NOTE:** Make sure battery dock on bottom pole is lined up with ON/OFF switch and USB port on housing. Line up button with hole and snap into place.

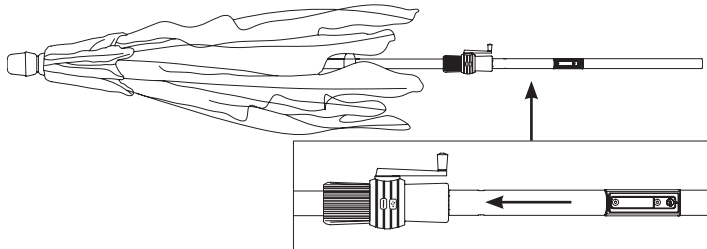

**IMPORTANT:**

If you are using a BW Classic Base with your Starlux Collar Tilt, you must attach Base Stopper to your BW Classic Base (see Step 2 below). If you are not using a BW Classic Base OR if you have a BW30 Add-on Weight attached to your BW Classic Base, please proceed to Step 3.

**STEP 2** *BW BASE STOPPER (FOR BW CLASSIC BASE ONLY)* —

To avoid the BW Classic Base stem from interfering with the battery, base stopper must be installed under base.

Turn BW Classic Base on its side. Attach Base Stopper to underside of base by turning clockwise until tightened. Turn base back to upright position.

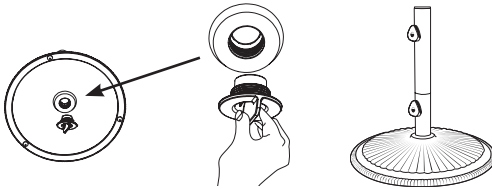

**STEP 3** *RECHARGEABLE BATTERY PACK* —

Turn umbrella in upright position. Insert bottom pole into free standing base or through table top. **IMPORTANT:** If using table application, please take note of measurements below to ensure table can accommodate battery pack.

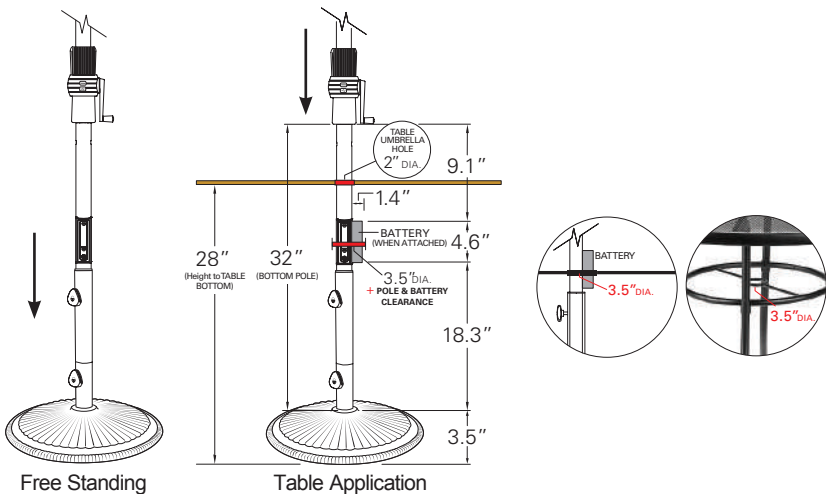

Attach rechargeable battery pack onto bottom pole.

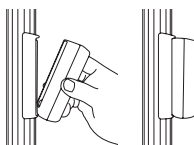

### Charging Battery Pack:

**IMPORTANT:** You must fully charge battery pack prior to first use.

To charge battery, remove plug cap from charging port on battery pack. Using the power supply included with umbrella, insert power supply into charging port. Plug other end of power supply into wall outlet for 6 hours to fully charge. When fully charged, all 4 lights displayed on battery pack will be illuminated.

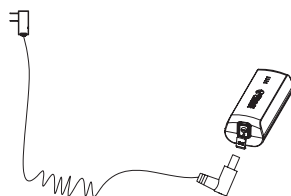

**Battery Status:** Lights on the battery pack will indicate battery charge level. Four lights indicates full charge, while one is low battery. When battery is low, you may charge battery pack while attached to frame, or removed from frame, using power supply included with umbrella.

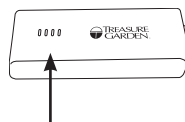

**Note:** The transformer output power is 5VDC 2A. During prolonged use, it is normal for the power supply to be warm to the touch. When using power supply, avoid direct sunlight and exposure to moisture.

## STEP 4

### OPENING & TILTING UMBRELLA

Crank handle clockwise to open umbrella to its fully open position. To tilt, simply twist the collar in clockwise direction until desired tilt position is reached.

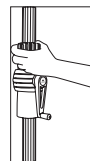
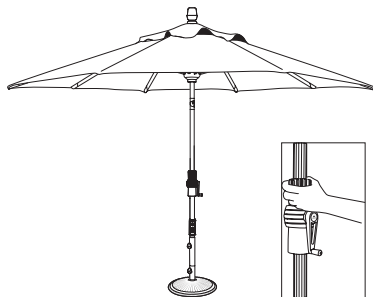

To tilt

## STEP 5 LIGHTS

To turn umbrella lights on or off, press on/off switch located on collar housing.

**WARNING:** We do not recommend use of lights while raining. When lights are not in use, remove battery pack from umbrella. Store battery pack, along with power supply in dry, cool area to keep from damaging.

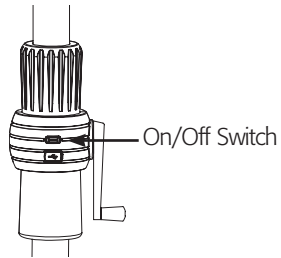

## STEP 6 USB PORT

To charge electronic devices, remove plug from USB port. Insert USB cable into USB port. Reattach plug when not in use. **NOTE:** If using USB port and lights, battery life will reduce to 4 hours.

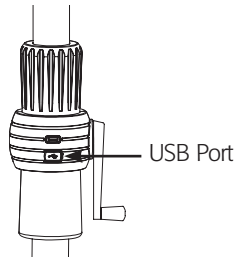

## STEP CLOSING UMBRELLA

Twist collar in counter-clockwise direction to bring umbrella back to a horizontal position. Turn crank handle in counter-clockwise direction to close umbrella. Tie string around canopy and cover umbrella with protective cover (sold separately).



## SAFETY PRECAUTIONS

- Close and store the umbrella in windy conditions or when a storm approaches. Never allow the umbrella to flap in the wind; this could damage the canopy.
- Do not leave open umbrella unattended. If damage occurs, this is not covered by the warranty.
- When adjusting the umbrella, make sure that no person(s) or item(s) are close to the umbrella. This is important to prevent injury or material damage.
- Do not operate the Starlux power switch, USB port or attempt to charge the umbrella in inclement weather (rain, snow) so as to prevent damage to the electrical components.

### Rechargeable Battery Pack and Power Supply:

- Discontinue battery usage if leakage is found. Contact your local authorized dealer for a replacement.
- Do not disassemble rechargeable battery pack.
- Do not leave rechargeable battery pack in sun, it will affect battery life.
- Never use a third party battery or power supply. Doing so may increase risk of fire or explosion. Contact your local authorized dealer for a replacement rechargeable battery pack or power supply.
- During prolonged use, it is normal for the power supply to be warm to the touch. When using power supply, avoid direct sunlight and exposure to moisture.
- Do not attempt to charge the umbrella in inclement weather (rain, snow) so as to prevent damage to the electrical components.

#### Rechargeable Battery Pack Information

Input: 5V 2A

Output: 3.7V 6000mAh

#### Power Supply Information

Input voltage: 100-240Vac 50/60Hz 0.3A

Output: 5VDC 2A

26.5' Cord

#### USB Information

USB 2.0 Output: 5V 500mA

## CARE AND MAINTENANCE

- When not in use, close and cover umbrella with a protective cover (not included).
- Store rechargeable battery pack and power supply in dry place.
- Allow a wet canopy to dry while in open position, but do not leave unattended.
- If necessary, clean the fabric with lukewarm water, mild detergent, and a sponge.
- Wipe sliding marks on the aluminum poles with a damp cloth.

#### Winter Storage:

- Store in a dry place.
- Store battery pack, along with power supply in dry, cool area to keep from damaging.

#### After the Winter:

- Check the condition and function of the umbrella. Any defects must be repaired by a professional.

**WARRANTY:**

Treasure Garden warrants this product (in residential use) to be free from defects in original materials and workmanship for a period of 2 years from the date of purchase. If a defect in the original material or workmanship appears during the warranty period; Treasure Garden will (at its option) repair or replace the product without charge.

Simply contact your original authorized Treasure Garden dealer with a description of the defect. The dealer will verify the defect and work closely with Treasure Garden to obtain the necessary service. In many cases, simple problems can be solved with a replacement part that can be shipped directly to the dealer for professional installation / repair.

In the event that warranted factory service is required, Treasure Garden will assume the responsibility of the return freight

charges on warranted product for the first year only.

Returned product that (upon receipt and inspection) is deemed to be "not covered" under our warranty, will be shipped / billed at your expense.

This warranty gives you specific legal rights, and you may have other rights which vary from state to state.

**RUST:** Rust is a natural part of the aging process of steel or iron based materials, and is therefore NOT considered a defect.

**NOTE:** Failure caused by unreasonable or abusive use, or failure caused by neglect of reasonable and necessary care are not covered by this warranty.

Additionally, acts of nature (including but not limited to wind, hurricanes, tornadoes, and storms) are not covered by this warranty.

-----



[www.treasuregarden.com](http://www.treasuregarden.com)

©2020 Treasure Garden, Inc. - All Rights Reserved.  
v.03.5.20