

 TREASURE GARDEN

BKM/BKMSQ Series Monaco

100_{LB}

Cast Aluminum Base with Wheels & Handle

Assembly and Operation Guide

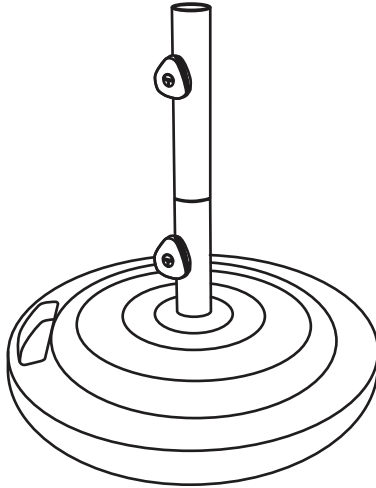

Thank you for your purchase of Treasure Garden's Monaco BKM100/BKMSQ100 Series Base with Wheels and Handle.

Please remove all contents from the package, inspect and review checklist.

MONACO BASE CHECKLIST

- A - Upper Stem 11 in.
- B - Reduced Stem 6.5 in.
- C - Full Stem 17.5 in.
- D - Knobs (2)
- E - Base
- F - Wheels (2)
- G - Handle

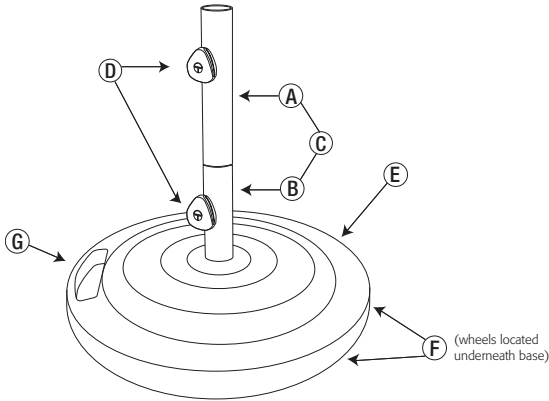

Set Up

Attach stem to base and turn stem clockwise  until fully tightened. Your base is now ready for use.

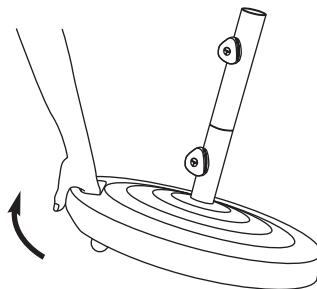
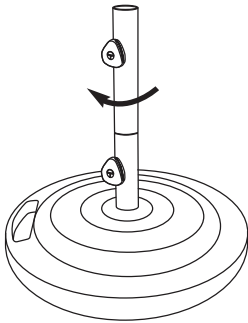

Easy to move your shade -
Lift at handle, base rolls
easily on 2 wheels

Dimensions

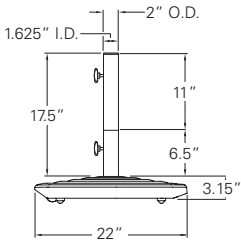

Monaco Round

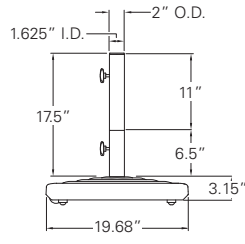
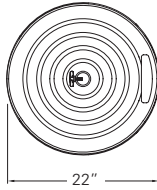

Monaco Square

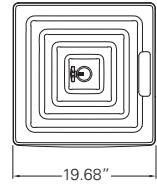

WARRANTY:

Treasure Garden warrants this product to be free from defects in original materials and workmanship for a period of 1 year from the date of purchase. If a defect in the original material or workmanship appears during the warranty period; Treasure Garden will (at its option) repair or replace the product without charge.

Simply contact your original authorized Treasure Garden dealer with a description of the defect. The dealer will verify the defect and work closely with Treasure Garden to obtain the necessary service. In many cases, simple problems can be solved with a replacement part that can be shipped directly to the dealer for professional installation / repair.

In the event that warranted factory service is required, Treasure Garden will assume the responsibility of the return

freight charges on warranted product for the first year only.

Returned product that (upon receipt and inspection) is deemed to be "not covered" under our warranty, will be shipped / billed at your expense.

This warranty gives you specific legal rights, and you may have other rights which vary from state to state.

RUST: Rust is a natural part of the aging process of steel or iron based materials, and is therefore NOT considered a defect.

NOTE: Failure caused by unreasonable or abusive use, or failure caused by neglect of reasonable and necessary care are not covered by this warranty.

Additionally, acts of nature (including but not limited to wind, hurricanes, tornadoes, and storms) are not covered by this warranty.

CAUTION: HANDLE WITH CARE

- To reduce personal injury and damage, read and follow this Assembly and Operation information.
- Close the umbrella in windy conditions or when a storm approaches. Never allow the umbrella to flap in the wind; this could damage the canopy.
- Do not leave open umbrella unattended.
- Do not allow children to play on or with the base.



www.treasuregarden.com

©2013 Treasure Garden, Inc. - All Rights Reserved.

Rev.12/13