

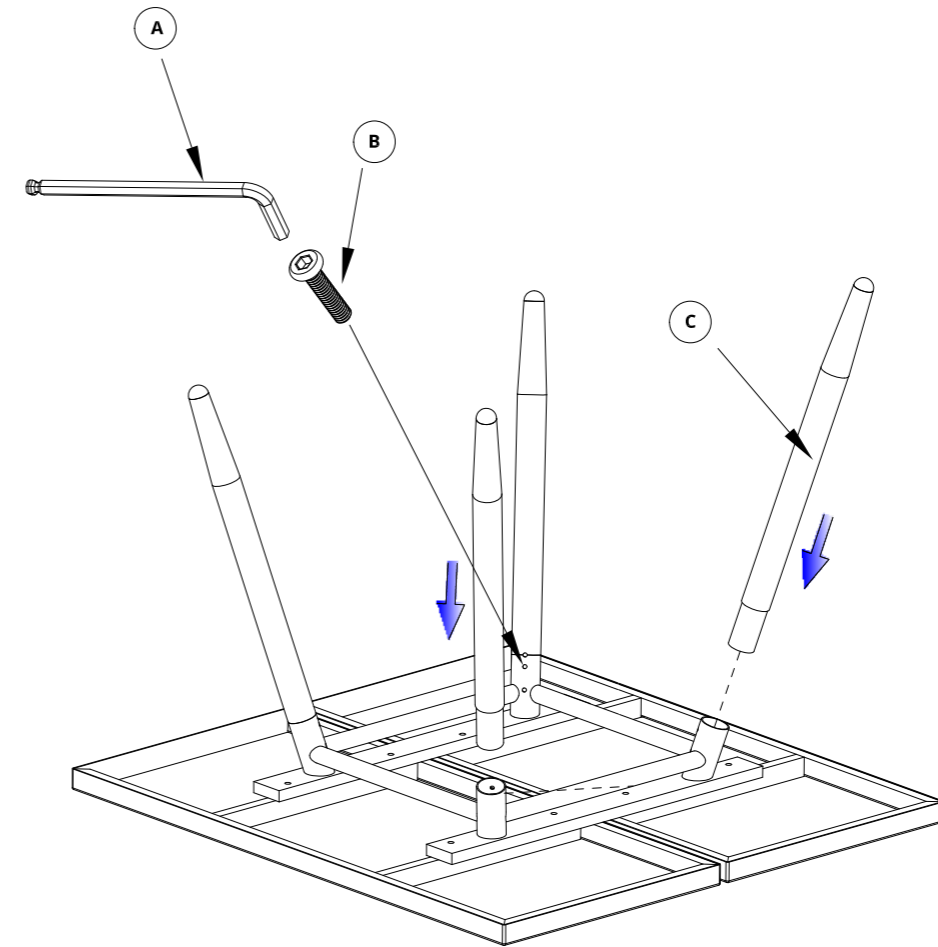

# Stipa Aluminium Table 100x100

Assembly Guide

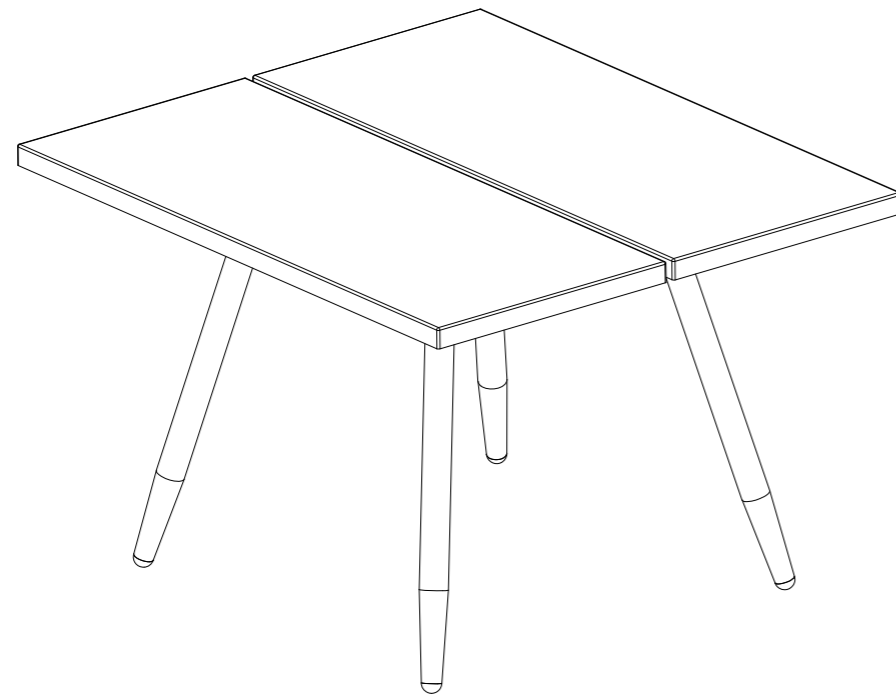

- Identify all the components before start assembling
- Choose a location close to the place where you intent to use this furniture
- Use a clean and even surface for assembly
- We recommend using carton paper under the furniture during assembly
- Do not throw away the packaging until finished assembling
- Ensure no fittings and components are disposed when discarding

A

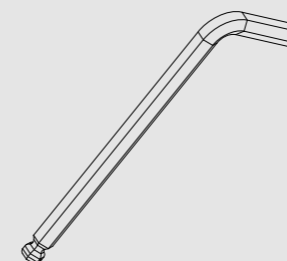

B

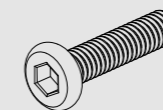

X 8

C

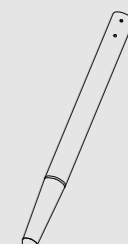

X 4