



# POLYWOOD

## Assembly Instructions



### Having Trouble?

If you have questions or concerns regarding assembly instructions or missing parts, please contact us at **(833) 665-6300** or email [support@polywoodoutdoor.com](mailto:support@polywoodoutdoor.com)

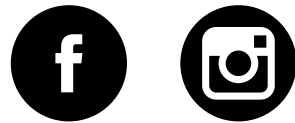

### Share your space

We love to see where our furniture ends up — snap a pic and share it on Instagram or Facebook!  
**#polywood**



### Watch & Learn

For assembly videos and more, visit [youtube.com/polywood](https://www.youtube.com/polywood)

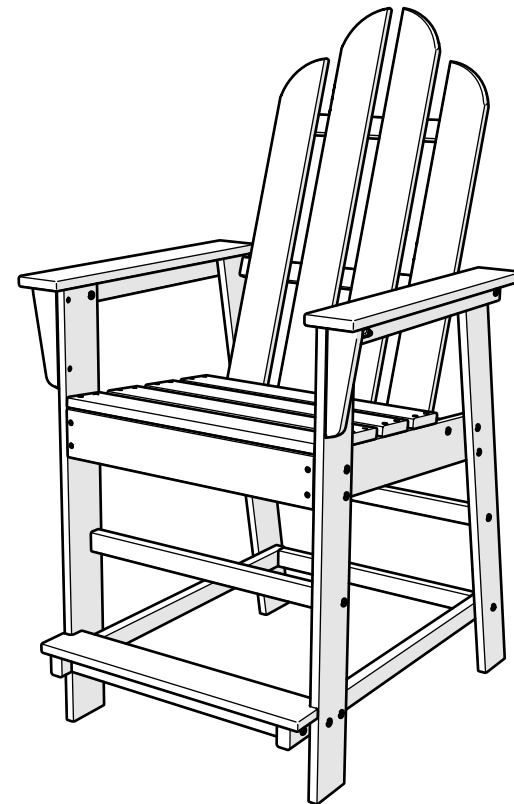

## ECD24 Long Island Counter Chair

### 20-Year Warranty

To view our full warranty, please visit [polywoodoutdoor.com/warranty](https://polywoodoutdoor.com/warranty)

Easily register your product using one of the methods below:

**Text POLYWOOD to 71403**  
Receive a link to register online

— or —

**Register on our website**  
[register.polywoodoutdoor.com](https://register.polywoodoutdoor.com)

— or —

**Send a Picture**  
Take a photo of the icon below and text it to 71403 (US only)

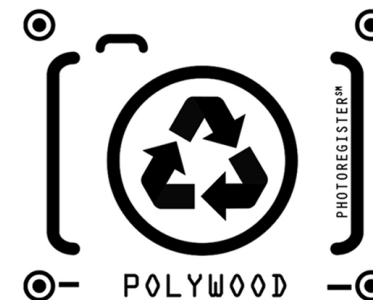

### Cleaning Tips

Even POLYWOOD gets dirty — here are some ways to help keep it clean:

**For a quick clean:**  
Simply wipe down with soap and water.

**For a deeper clean:**  
You'll need:  
» 1/3 bleach and 2/3 water solution  
» clean cloth  
» soft bristle brush  
Wipe on solution with your cloth and let it sit on the lumber for a few minutes (this will not affect the color). Then, loosen any dirt and debris that may catch in surface grooves with a soft bristle brush; hose down to rinse.

# TOOLS

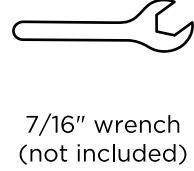
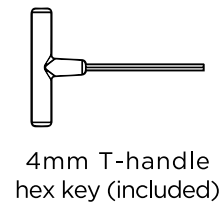

# PARTS

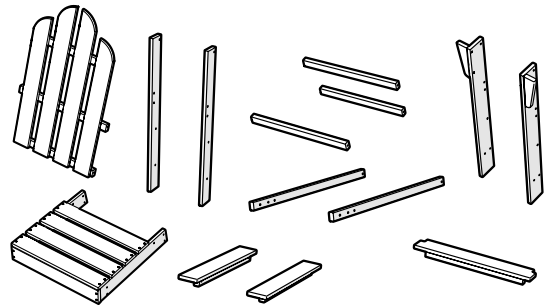

**A** x 8

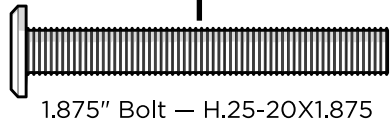

**B** x 6

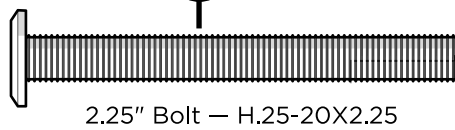

**C** x 8

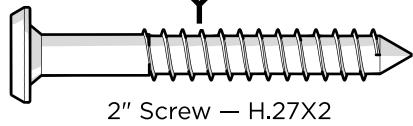

**D** x 4

Flange Nylon Lock Nut  
HN.25-20

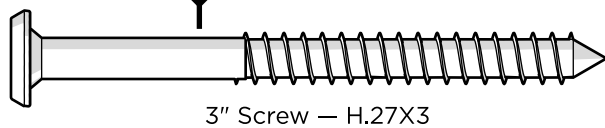

Something missing?  
Call (833) 665-6300

